

Varenummer: 20073510
 Beskrivelse: E+G Aksial kugleled
 GN 782-M8-KI-2

Mål

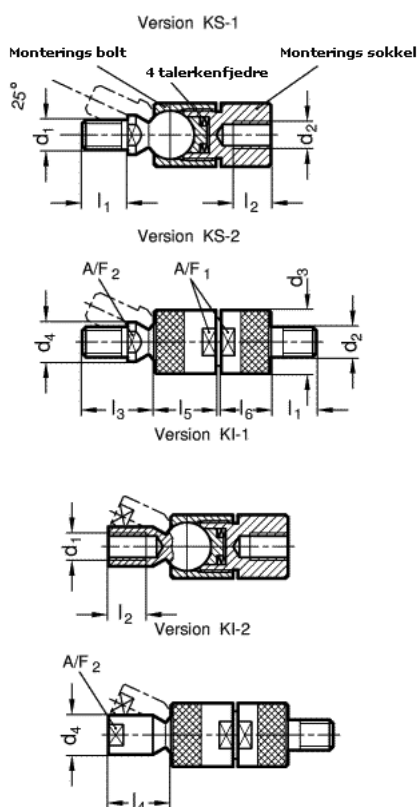

$d_1 = M 8$	$l_5 = 18.5$
$d_2 = M 8$	$l_6 = 15$
$d_3 = 19$	$sw1 = 17$
$d_4 = 11$	$sw2 = 9$
$l_1 = 12$	
$l_2 = 10$	
$l_3 = 19.5$	
$l_4 = 18.0$	